

MPIC-Slope User Manual



Copyright

About MPIC-Slope

Version: TI.059 Rev REL 12/10/2015

Documentation Date: 12-10-2015

Copyright

Copyright © 2016. Riverside MFG LLC. All rights reserved. No part of this publication may be reproduced, transmitted, transcribed, stored in a retrieval system, or translated into any language in any form without prior written consent from Riverside. This software product, including the manual and media, is copyrighted and contains proprietary information that is subject to change without notice. The software may be used only in accordance with the terms of the license agreement. TouchTek is a trademark of Riverside. All other trademarks or registered trademarks are acknowledged as the exclusive property of their respective owners.

Contact Information

Riverside MFG LLC

14510 Lima Road

Fort Wayne, IN. 46818 USA

E-mail: sales@riversidemfg.com

Revision Log

Revision	Date	Author	Affected Section/s	Description
Rel	12/10/15	Z. Bearss		Initial Release

Precautions and Warnings

Very important information. Please read this section carefully before using this product.

All operators **MUST** read and understand this manual and the warnings and cautions set forth herein prior to using this product. Riverside MFG LLC is not responsible for injuries, damages, issues or problems resulting from the failure to observe the precautions, warnings, and instructions in this manual. This product is safe if used in accordance with the guidelines set forth in this manual.

Store this guide where it will be accessible at all times, for example in your glove compartment.

- This product is not a substitute for your driving knowledge or your personal judgment.
- When your vehicle is moving, keep your eyes on the road, NOT on the control panel. If you need to look at the control panel for a prolonged time, always park the vehicle in a safe manner and in accordance with all traffic regulations.
- Do not change settings or otherwise manually operate this system while the vehicle is moving.
- Immediately stop using the system if a problem arises. Report all problems to your designated dealer.
- It is your responsibility to always comply with all traffic regulations.
- Stop the vehicle before performing any system operation that could interfere with driving.

Table of Contents

Table of Contents	5
Chapter 1 – Introduction.....	7
MPIC-Slope Overview.....	7
About This Guide.....	7
Customer Support	8
Quick Reference Tables.....	8
Chapter 2 – MPIC-Slope Summary.....	9
Features	9
Specifications	9
Chapter 3 – Quick Start.....	10
Installation	10
Easy Setup Guide.....	10
Chapter 4 – Using the MPIC-Slope.....	12
Installation	12
1. Connector Description.....	12
2. Momentary Switch Input.....	12
3. External Siren Output.....	12
4. Installing the MPIC-Slope	12
Power Up.....	13
1. Splash Screen.....	13
2. Set Point Screen	13
3. Home Screen	13
Safety Notifications	14
Navigation	14
1. Gesture Recognition Sensor Area.....	14
2. Gesture Recognition “Hold”	15
3. Gesture Recognition “Swipe”	15
Configuration	16
1. Factory Configuration.....	16
2. Settings Menu Overview	16
3. Entering the Settings Menu.....	16
4. Navigating the Settings Menu	17
5. Audible Alarm Enable	18
6. Audible Alarm Set Point	19
7. Visual Alarm Set Point	21
8. Calibration	23

9.	Home Screen Selection.....	25
10.	Reset to Factory Default	28
11.	Exit Settings Menu	29
Chapter 5 – Data Logger		30
Data Logging.....		30
1.	Installation of MPIC-Slope Data Logger Software	30
2.	Connecting the MPIC-Slope to the MPIC-Slope Data Logger Software	33
3.	Download the MPIC-Slope Memory	34
4.	Data Logger Download File.....	35
5.	Clear the MPIC-Slope Memory	36
Chapter 6—Glossary		38
Glossary of Terms.....		38

Chapter 1 – Introduction



FIGURE 1.1: MPIC-SLOPE (PART NUMBER: 20283)

MPIC-Slope Overview

The MPIC-Slope Gauge offers a compact and ruggedized solution for providing real time pitch, roll, slope, and/or grade data for direct sunlight and low ambient light environments. This gauge can be controlled through simple gesture recognition commands. This gauge incorporates MEMs technology utilizing a 3 axis accelerometer and gyroscope to provide vibration and acceleration compensated output utilizing a sensor fusion algorithm. Multiple settings allow the user to change warning set points, audible, home screen graphics, and an auto zero calibration function. For ease of use, the gauge comes with default settings for a truly turnkey solution. It automatically captures the last 50 hours' worth of data for data logging purposes. A PC application used for downloading captured data is available for reviewing the information.

About This Guide

This manual is organized as follows:

Chapter 1—Introduction: introduces this manual.

Chapter 2—MPIC-Slope Summary: provides a brief overview of the MPIC-Slope, how it works and how it is used.

Chapter 3—Quick Start: describes how to get the MPIC-Slope up and running fast.

Chapter 4—Using the MPIC-Slope: gives instruction on and describes every feature on the MPIC-Slope.

Chapter 5—Data Logger: gives instructions on the data logger feature and what the data means.

Chapter 6—Glossary: describes technical terms in detail.

Note: The steps and procedures presented in this guide represent the best practice methods for working successfully with the MPIC-Slope. If you have any questions or encounter any difficulties that are not addressed in the documentation or tech support, contact Customer Support. In addition, please note that the information in this guide, including references to the various graphical elements in the system, is subject to change due to on-going updates and improvements. The latest version of this guide can be downloaded from the Riverside MFG LLC website: <http://www.riversidemfg.com>

Customer Support

Visiting the Riverside Manufacturing website is the fastest, most convenient way to receive technical support and service. You can also find additional supporting documentation and purchasing information.

If you find you need to contact Riverside Mfg., LLC. directly, customer service representatives are available by phone from 8:00am to 4:30pm (Eastern Time), Monday-Friday. To contact us by phone, call (260) 637-4470.

If you need Technical Support, Parts or Service, it helps to have the following information available:

- Business Name & Location
- Module Number or Part Number
- Nature of the Problem

Quick Reference Tables

Table 2.1: <i>MPIC-Slope Technical Information</i>	9
Table 4.1: <i>MPIC-Slope connector information</i>	12
Table 4.2: <i>MPIC-Slope connector pin out information</i>	12
Table 4.3: <i>MPIC-Slope factory configuration settings</i>	16

Chapter 2 – MPIC-Slope Summary

Features

The MPIC-Slope has the following features:

- 5 home screens to choose from that display slope, pitch, and/or roll
- Gesture recognition for settings navigation plus supports an external input
- Audible and visual slope warnings with programmable set points
- Slope can be calibrated
- Data logging
- Backlight in low ambient settings
- Sensor fusion algorithm to calculate high accuracy roll, pitch, and slope
 - Only accurate from 0 to 90°.
 - Stationary with high vibrations has an accuracy of about $\pm 1^\circ$.
 - Rotation of device has an accuracy of about $\pm 5^\circ$.
 - Acceleration/Deceleration has an accuracy of about $\pm 5^\circ$.

Specifications

The MPIC-Slope has the following specifications:

- Size: 2.5" diameter bezel, fits in 2" diameter hole, 1.25" overall height
- Operating Temperature Range: -20° C to 70° C
- Environmental Sealing: IP67
- Operating Voltage 5-28VDC
- On State Current Consumption: 300 mA approximately
- Off State Current Consumption: 0 mA
- Protection: reverse polarity, backfeed, and under/over voltage

TABLE 2.1: MPIC-SLOPE TECHNICAL INFORMATION

Module	P/N	Inputs	Outputs	Input Voltage	Dimensions	Mounting Hole Pattern
MPIC-Slope	20283	1 Digital	1	5-28 VDC	2.5" x 2.5" x 1.36"	2"

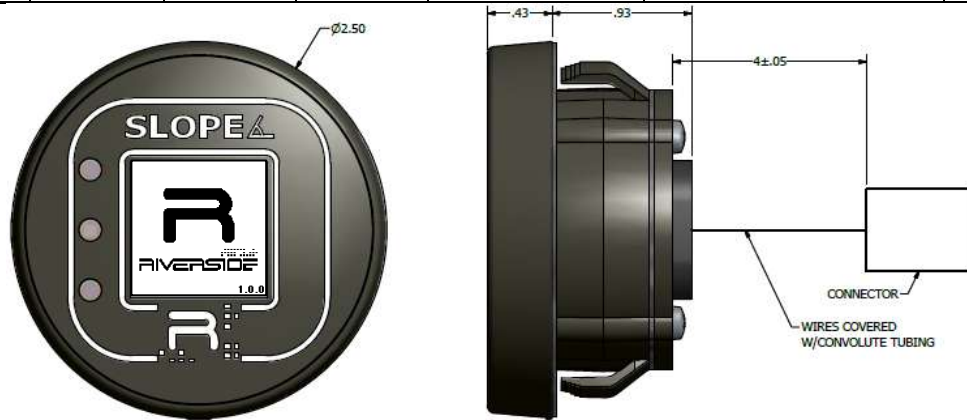


FIGURE 2.1: MPIC-SLOPE DIMENSION

Chapter 3 – Quick Start

Installation

The first step is to create the mating connector harness (DT04-6P). PWR is the 1st pin and the GND is the 2nd pin. Next, install the mating connector harness.

Unless there is already a 2" hole that the MPIC-Slope firmly fits into, the next step is to cutout the hole for the MPIC-Slope using the cutout template. Make sure to use proper safety equipment and tools to make the cutout.

The next step is to connect the installed mating connector (DT04-6P) to the connector on the MPIC-Slope's connector (DT06-6S).

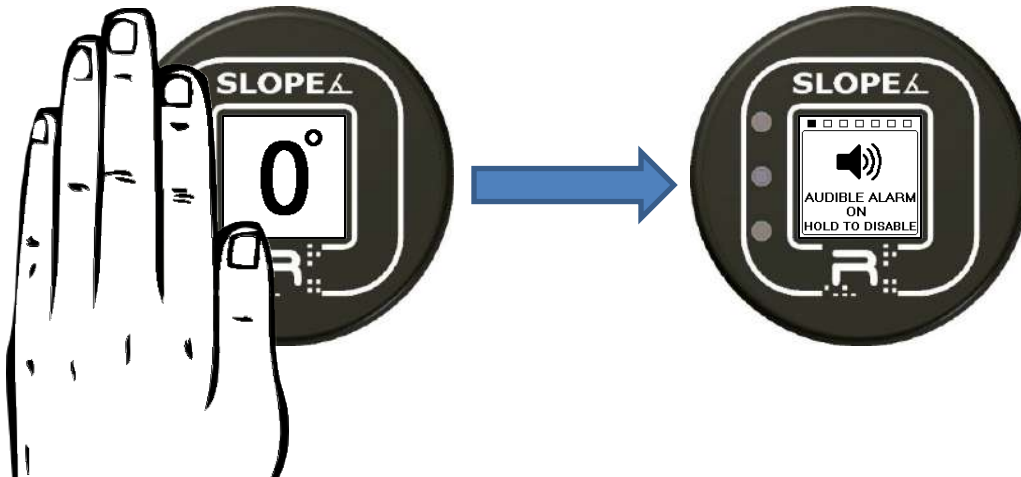
To finish the install, press fit the MPIC-Slope into the cutout. If desired, peel the adhesive backing from the rear of the gauge prior to installation to prevent un-intended rotation.

Easy Setup Guide

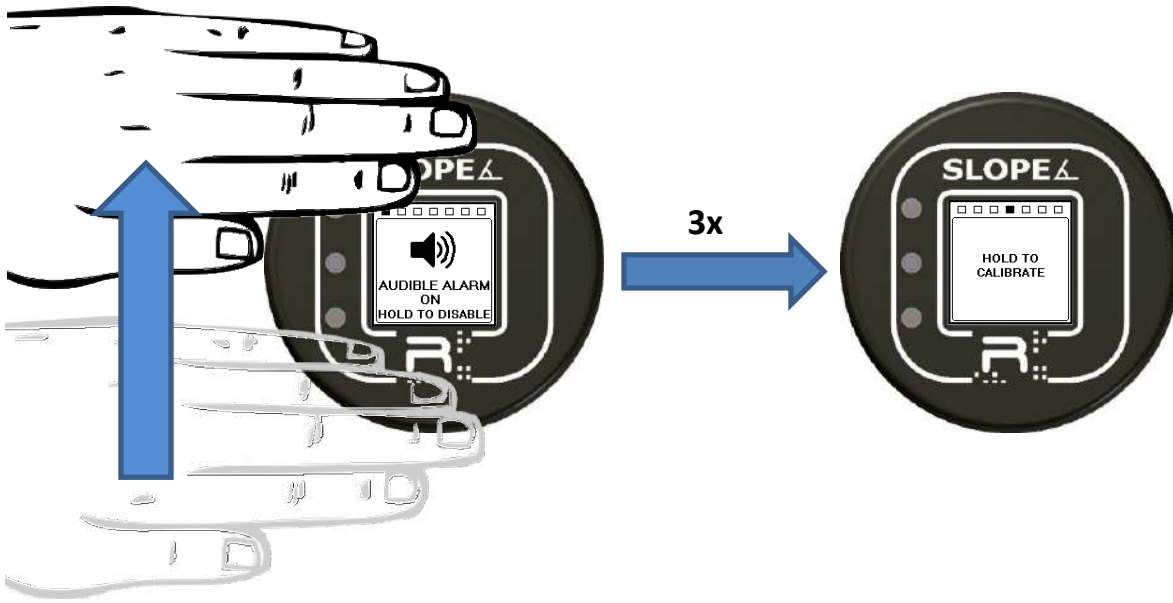
The main screen that is display on power up is the home screen. The factory configuration home screen will only display the slope. It will look something like this:



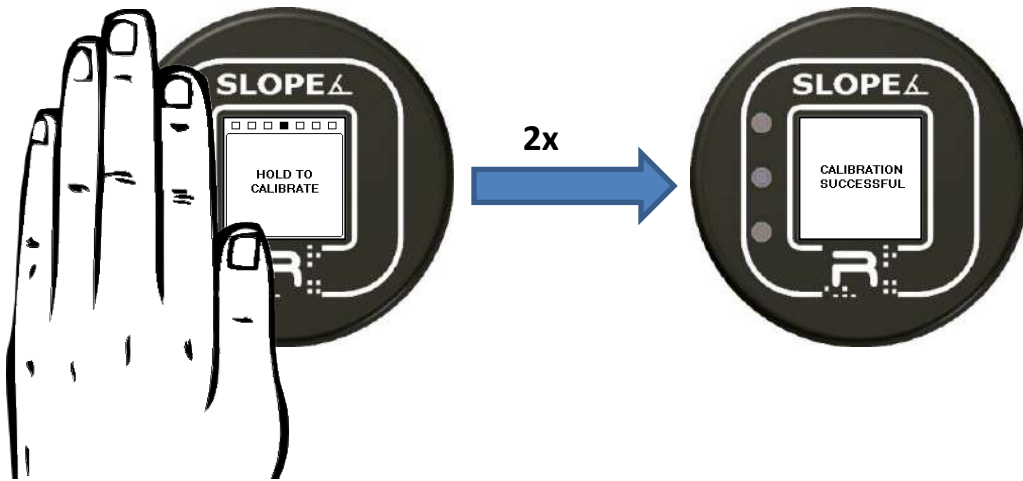
The first thing on power up, after it has been installed, is to calibrate the MPIC-Slope to the application it is being used in. This will zero out the value. In order to calibrate the device, you will have to access the calibration setting in the settings menu. This is how to enter the settings menu:



In order to get to the calibration screen in the settings menu, perform the following:



Finally, to finish the calibration process, perform the following:



Now you are set to use your MPIC-Slope.

Chapter 4 – Using the MPIC-Slope

Installation

Connector Description



FIGURE 4.1: THE MPIC-SLOPE CONNECTOR (PART NUMBER: DT06-6S)

TABLE 4.1: MPIC-SLOPE CONNECTOR INFORMATION

Reference Designator	Part Number	Contacts	Mating Part Number	Description
P1	DT06-6S	6	DT04-6P	Deutsch DT Series 6 Position Connector

TABLE 4.2: MPIC-SLOPE CONNECTOR PIN OUT INFORMATION

Signal Pin	Wire Color	I/O	Description	Voltage (nom. VDC)	Load (max. Amp.)
P1-1	White	PWR	Input power 5-28VDC	13.6V	1
P1-2	Black	GND	Ground	0	
P1-3	Orange	I	Momentary Switch Input	0	
P1-4	Pink	O	External Siren Output	0	
P1-5	Blue	I/O	CAN Differential Line	0	
P1-6	Green	I/O	CAN Differential Line	7	

Momentary Switch Input

If the gesture recognition is not ideal, the MPIC-Slope input can be connected to an external momentary switch. The momentary switch will act as a substitute for the gesture recognition. Instead of doing a gesture recognition “hold”, the momentary switch can be pressed and held instead, and for a gesture recognition “swipe”, the momentary switch can be pressed.

External Siren Output

The MPIC-Slope output can be connected to an external siren. When the slope goes beyond the audible alarm set point and the audible alarm is set to “ON”, the MPIC-Slope output will sound the external siren. The tone of the external siren will be an approximately 60 Hz tone.

Installing the MPIC-Slope

The installation of the MPIC-Slope is a simple process. The first step is determining what MPIC-Slope pins will be used on Table 4.2. The only wires absolutely needed are the PWR and GND wires. You can determine if you need the momentary switch input, 3rd pin, and the external siren output, 4th wire, by reading the two sections above. The next step is to create the mating connector harness

(DT04-6P). If an external siren will be used, connect it to the mating connector harness, and if a momentary switch input will be used, connect it to the mating connector harness. Next, install the mating connector harness.

Unless there is already a 2" hole that the MPIC-Slope firmly fits into, the next step is to cutout the hole for the MPIC-Slope using the cutout template. Make sure to use proper safety equipment and tools to make the cutout.

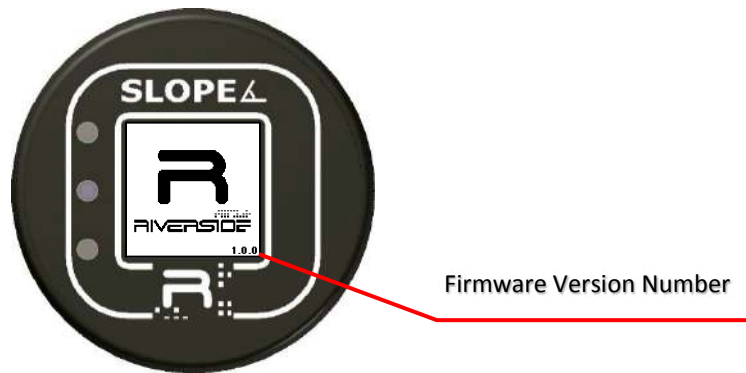
The next step is to connect the installed mating connector (DT04-6P) to the connector on the MPIC-Slope's connector (DT06-6S).

To finish the install, press fit the MPIC-Slope into the cutout. If desired, peel the adhesive backing from the rear of the gauge prior to installation to prevent un-intended rotation.

Power Up

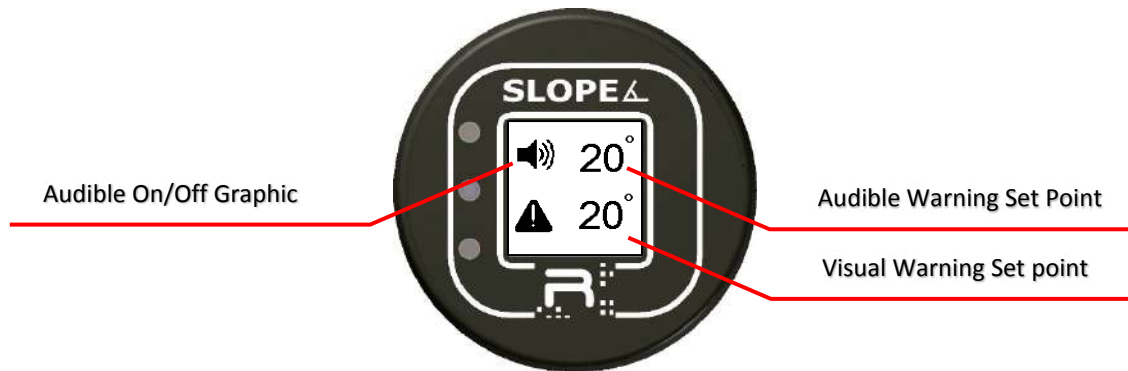
Splash Screen

Not only does the splash screen show Riverside's logo, it also shows the module's firmware version number. The splash screen is only shown for 2 seconds on power up.



Set Point Screen

The set point screen describes how the MPIC-Slope is configured. It shows the audible set point, the visual set point, and the speaker image will change when the sound is on or off. The set point screen is also only shown for 2 seconds on power up.



Home Screen

After the splash screen and the set point screen, the home screen is displayed on power up. The home screen is the main screen of the MPIC-Slope that displays the pitch, roll, slope, and/or grade. The home screen can be changed through the settings menu, which can be seen in the Home Screen Selection section in Chapter 4.

Safety Notifications

The MPIC-Slope contains safety features that help prevent applications from going on too high of a slope. Two of the safety features include the audible alarm and the visual warning. These warnings will be triggered when the slope is equal to, or greater than, their set points. The set points can be configured for both warnings in the settings menu. The audible alarm can be connected to an external siren. The visual warning will flash between the warning screen and the home screen, and the warning screen looks like this:

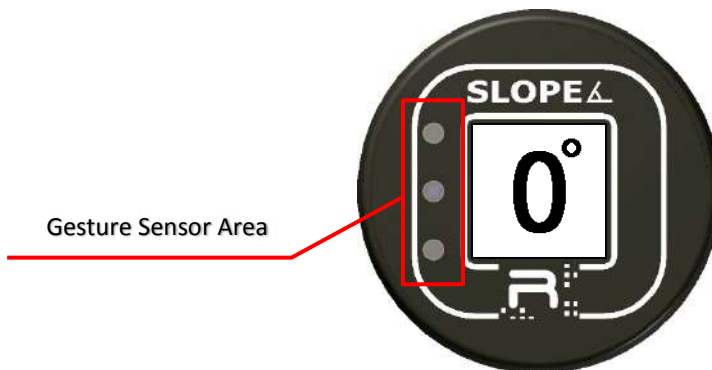


Note: The warnings will be disabled while in the settings menu.

Navigation

Gesture Recognition Sensor Area

The gesture recognition sensor area contains the three windows on the left hand side of the MPIC-Slope. Every gesture that is performed should be performed over all 3 gesture windows.



Gesture Recognition “Hold”

To perform a gesture recognition “Hold”, the user has to put their hand over the three gesture windows and hold it there for a certain length of time like in figure 4.2. The orientation of your hand does not affect it as long as all 3 gesture windows are covered.

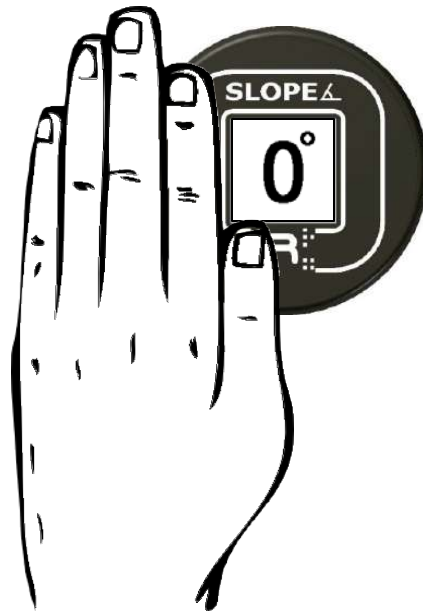


FIGURE 4.2: WHERE TO PLACE YOUR HAND FOR A GESTURE RECOGNITION “HOLD”.

Note: Your hand isn’t required for a gesture recognition “Hold”. It can be anything that is placed over all 3 gesture windows.

Gesture Recognition “Swipe”

To perform a gesture recognition “Swipe”, the user has to guide their hand from the bottom of the MPIC-Slope to the top making sure they went over every gesture window on the way up like in figure 4.3. This motion should be in a slow, steady pace. The orientation of your hand does not affect the “Swipe”.

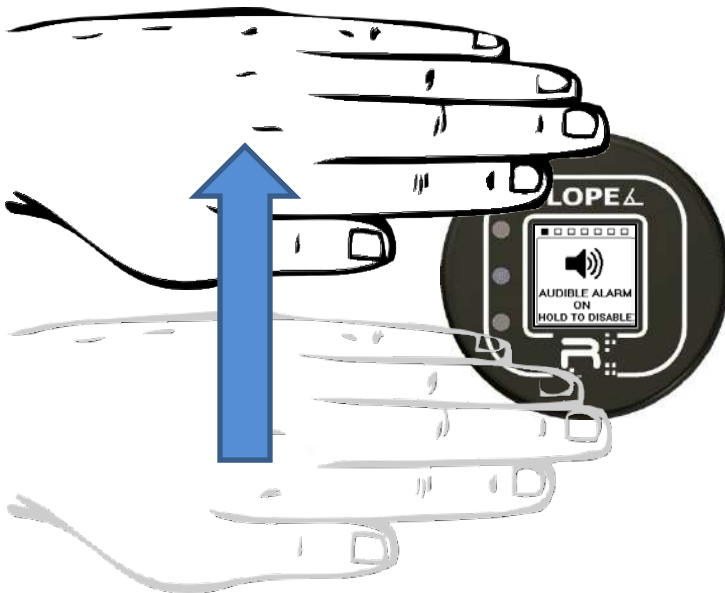


FIGURE 4.3: HOW TO PERFORM A GESTURE RECOGNITION “SWIPE”.

Note: Your hand is not required for a gesture recognition “Swipe”.

Configuration

Factory Configuration

The MPIC-Slope comes from the factory with a default configuration as seen in Table 4.3.

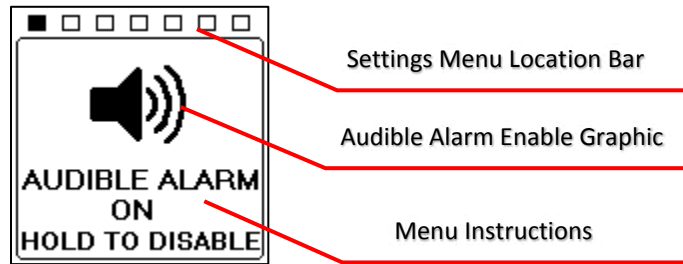
TABLE 4.3: MPIC-SLOPE FACTORY CONFIGURATION SETTINGS

HOME SCREEN	VISUAL SET POINT	AUDIBLE SET POINT	AUDIBLE ALARM	CALIBRATION
FACTORY DEFAULT (LARGE SLOPE)	20	20	ON	0 (FLAT DISPLAY UP)

Settings Menu Overview

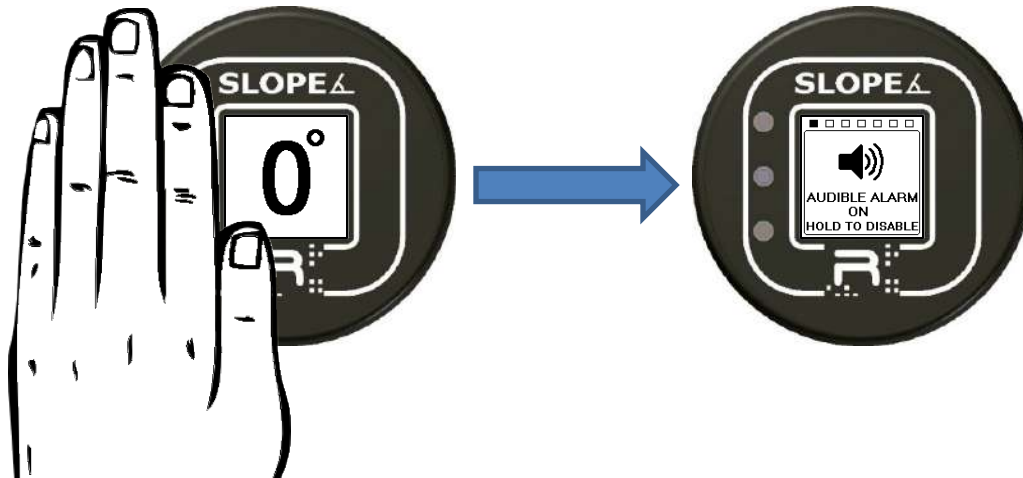


The settings menu allows you to configure the MPIC-Slope to be your own device. The settings menu contains a location bar at the top, which is 7 squares that represent the 7 settings screens. The filled in square is your current location in the settings menu. The settings menu also uses inactivity timers that will bring the MPIC-Slope back to the home screen. As an example of a settings menu screen, the 1st screen is the audible enable screen:



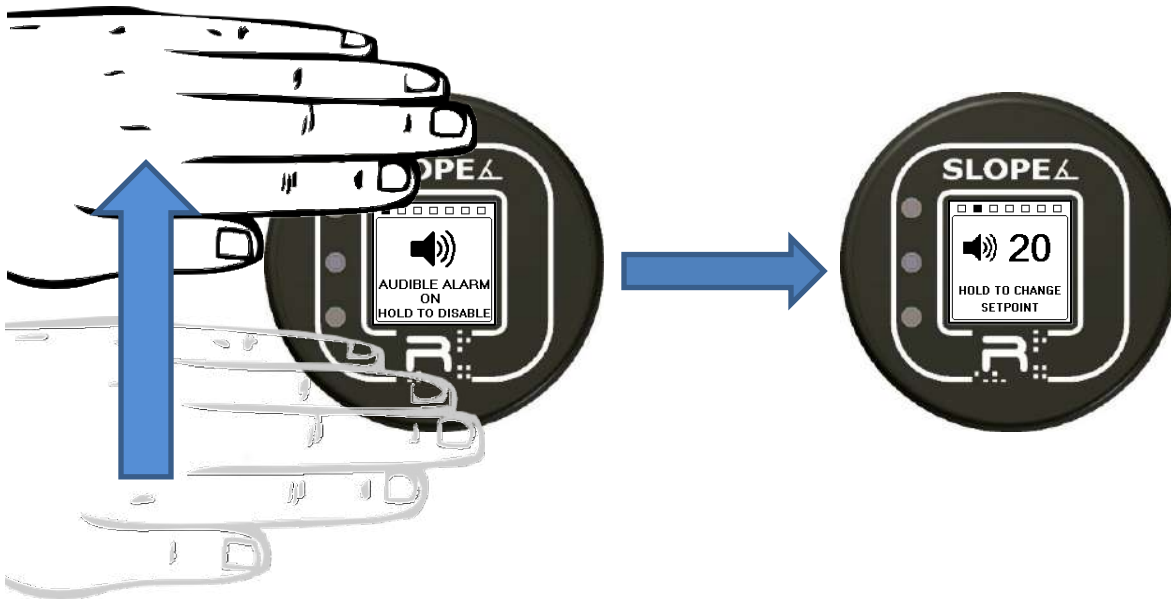
Entering the Settings Menu

In order to enter the settings menu, the user has to perform a gesture recognition “Hold” for approximately 8 seconds. The screen will change from the home screen to the settings menu.



Navigating the Settings Menu

In order to navigate the settings menu, the user has to perform gesture recognition "Swipes". The screen should cycle from one settings screen to another. As you navigate the settings menu, the settings menu location bar will update depending on which screen the MPIC-Slope is located on. The settings menu wraps around, so if the MPIC-Slope is on the last screen of the settings menu and perform a gesture recognition "Swipe", it will return to the first screen of the settings menu.

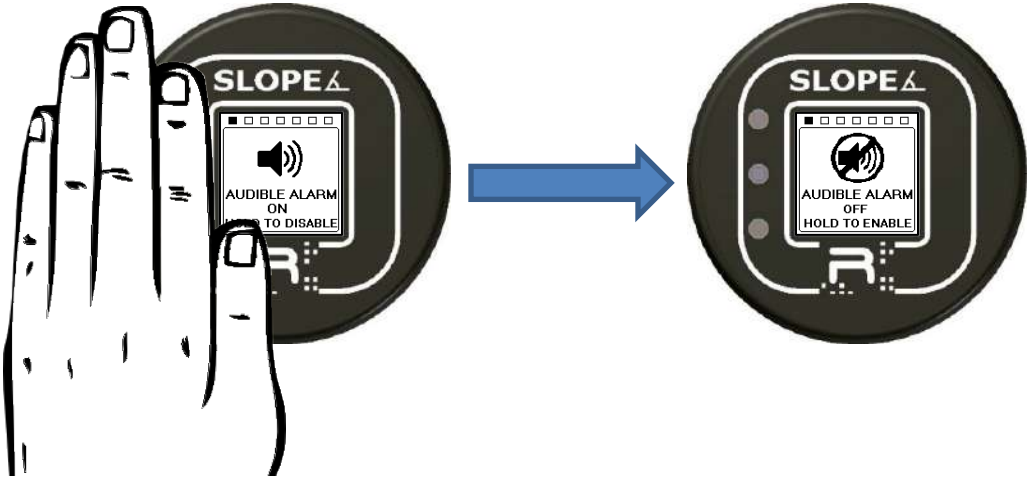


Audible Alarm Enable

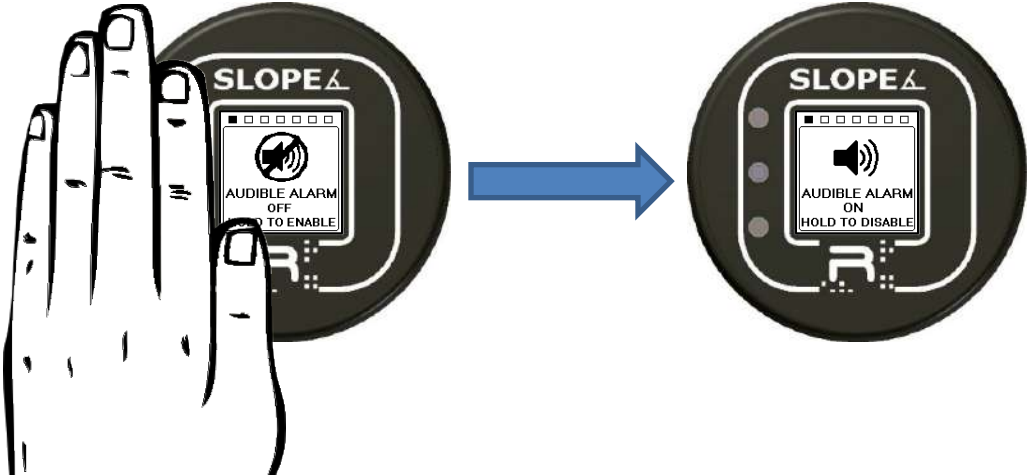


The audible alarm setting is located on the 1st page of the settings menu. If the audible alarm is disabled, the external siren will not go off even if the slope reaches the audible alarm set point.

To disable the audible alarm, perform a gesture recognition "Hold" for 3 seconds.



To enable the audible alarm, perform a gesture recognition "Hold for 3 seconds."



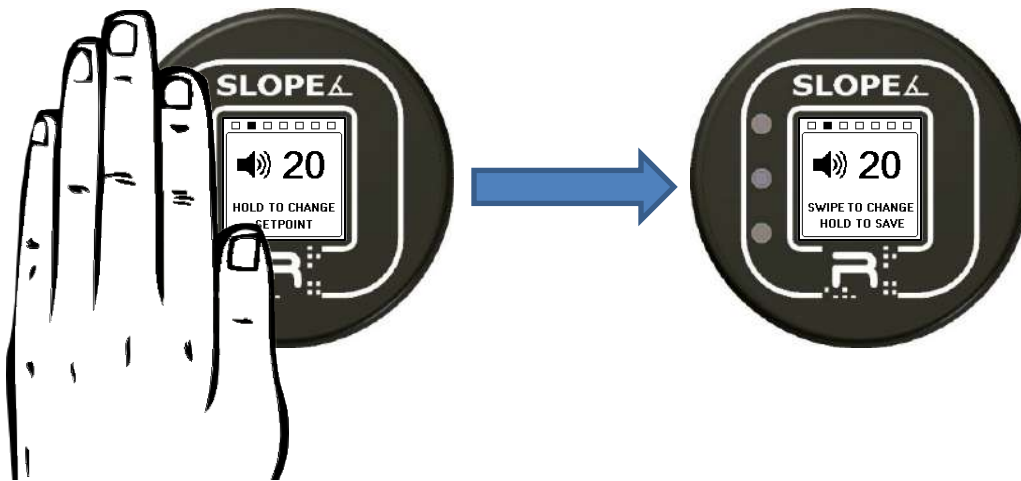
Audible Alarm Set Point



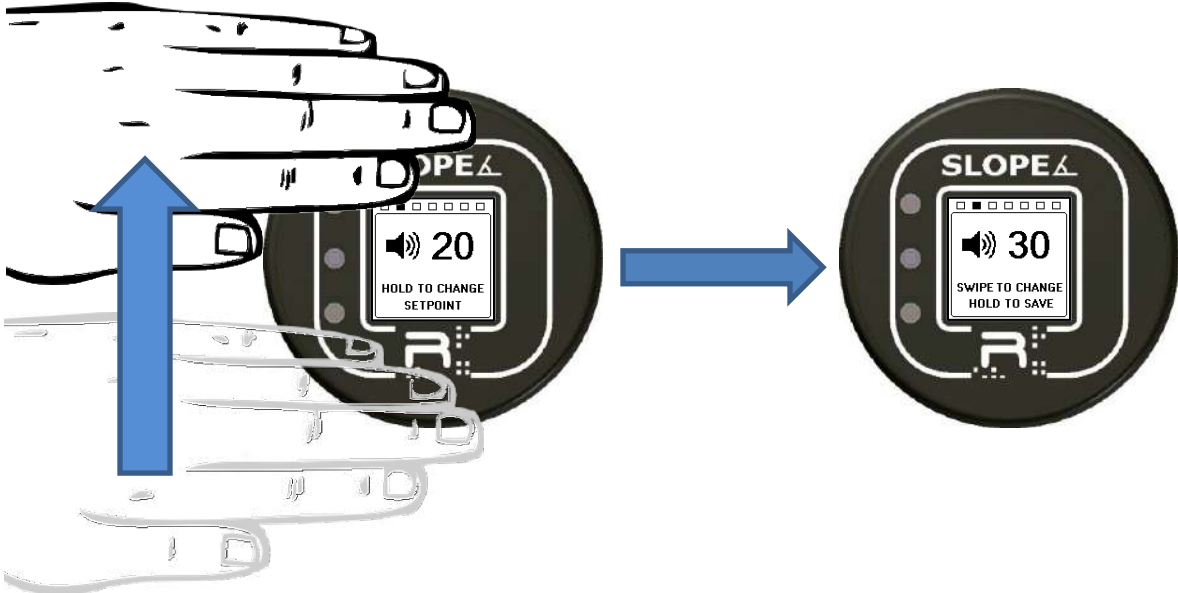
The audible alarm set point setting is located on the 2nd page of the settings menu. The set point defines the amount of slope that is required to sound the siren. The audible alarm will only be on when the home screen is being displayed. The range of the audible alarm set point can be from 5-30° in 5° increments.

To change the audible alarm set point:

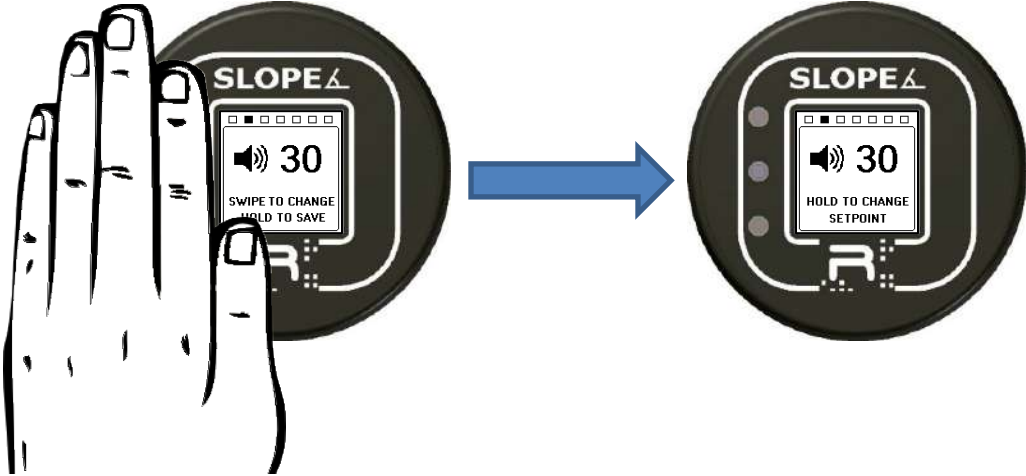
1. Perform a gesture recognition "Hold" for 3 seconds or until the set point number starts flashing.
 - a. If the user changes their mind, wait for the MPIC-Slope to time out in 30 seconds to go back in the settings menu.



2. The user will have to do a gesture recognition "Swipe" until the set point is the wanted value.



3. To save the set point value, perform a gesture recognition "Hold" for 3 seconds or until the number stops flashing.



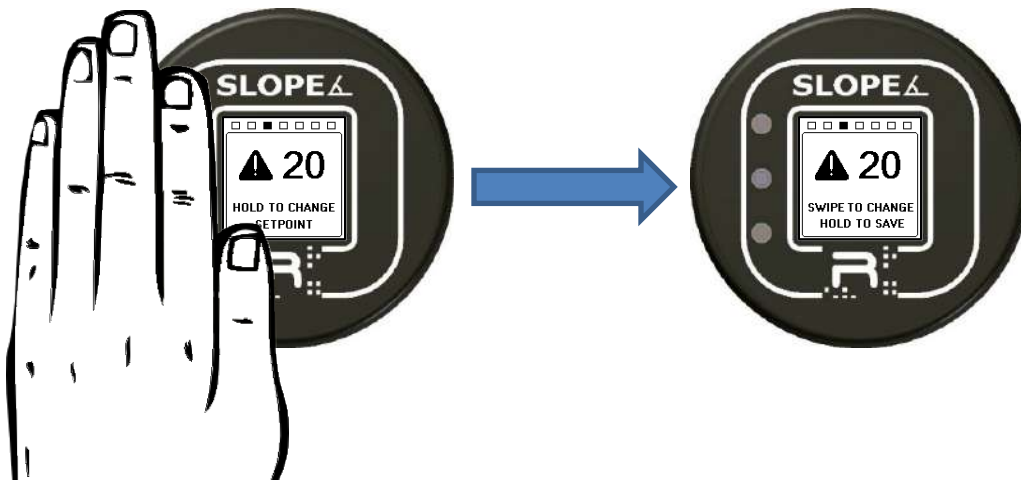
Visual Alarm Set Point



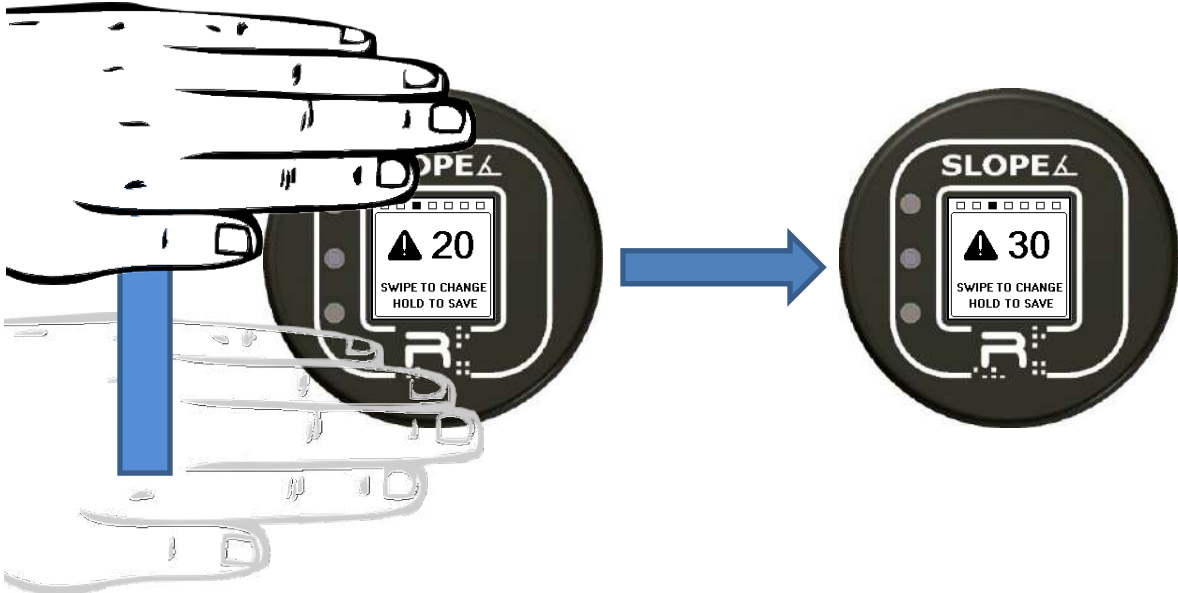
The visual alarm set point setting is located on the 3rd page of the settings menu. The set point defines the amount of slope required to display the visual warning. The visual warning will only be shown when the home screen is being displayed. The range of the visual alarm set point can be from 5-30° in 5° increments.

To change the visual alarm set point:

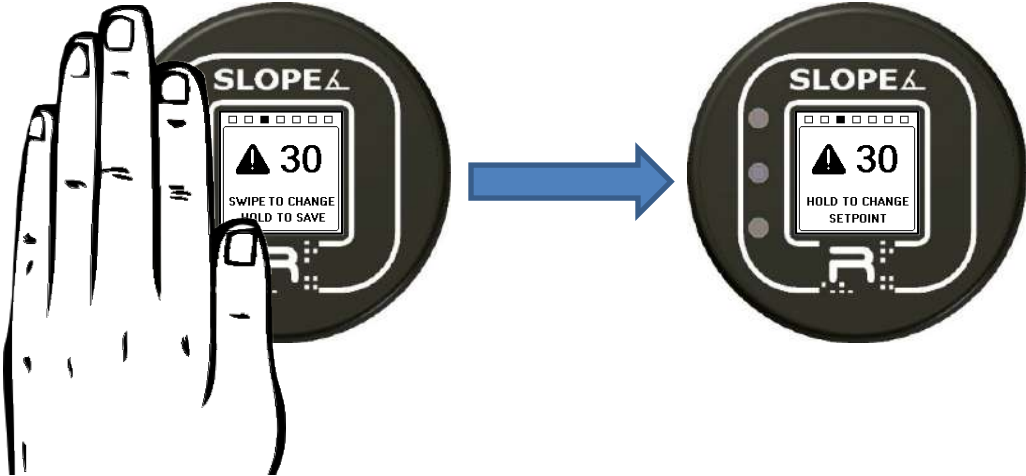
1. Perform a gesture recognition "Hold" for 3 seconds or until the set point number starts flashing.
 - a. If the user changes their mind, wait for the MPIC-Slope to time out in 30 seconds to go back in the settings menu.



2. The user will have to do a gesture recognition "Swipe" until the set point is the wanted value.



3. To save the set point value, perform a gesture recognition "Hold" for 3 seconds or until the number stops flashing.

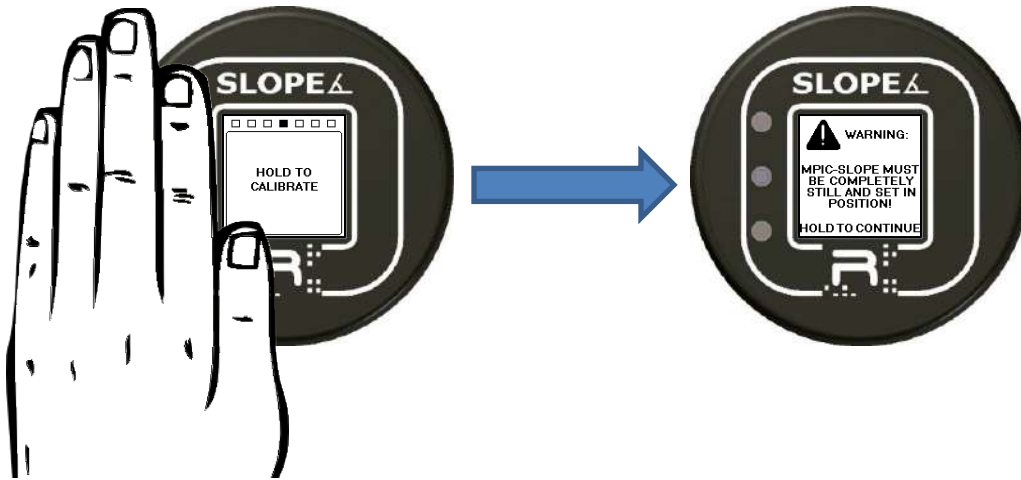


Calibration



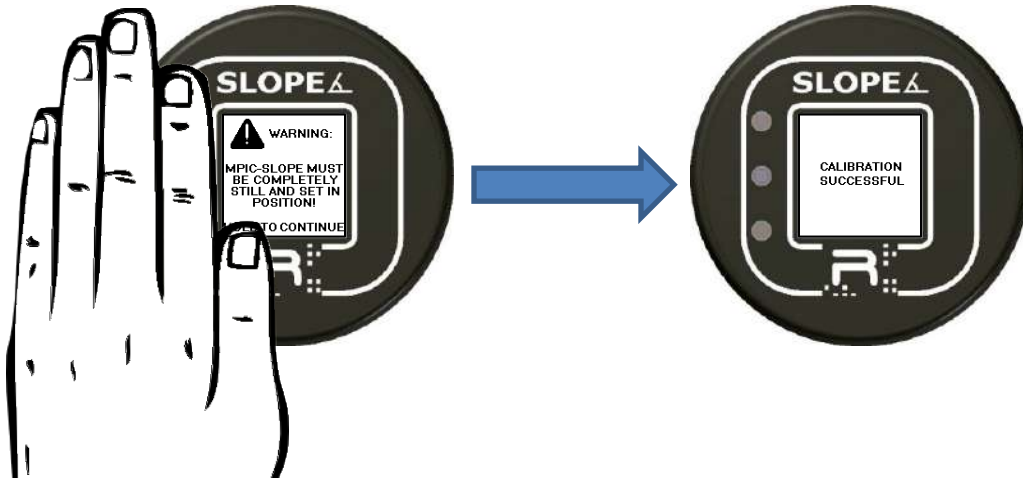
The calibration setting is located on the 4th page of the settings menu. After the MPIC-Slope has been installed, one of the first things that should be done is to calibrate the module for its installation. When calibrating the module, it should be at a level position that is considered a slope of 0, and it should not be in motion or have any vibration. If the MPIC-Slope is installed on a vehicle, make sure the vehicle is in accessories mode because if it is running it will vibrate the module. To calibrate the MPIC-Slope to a non-zero slope:

1. Perform a gesture recognition "Hold" for 3 seconds or the settings screen changes to a warning screen.
 - a. If you perform a gesture recognition "Swipe", it will exit back to the settings menu.
 - b. The MPIC-Slope will time out in 30 seconds to go back in the settings menu.



2. Make sure the MPIC-Slope is completely **STILL** and **LEVEL**.

3. Perform a gesture recognition “Hold for 3 seconds or until the “calibration successful” screen is flashing.



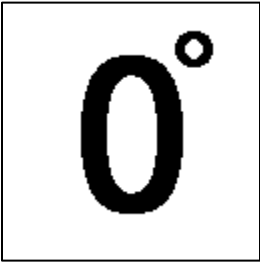
Warning: If the MPIC-Slope is not completely still for a calibration, the calibrated value can be off which can result in non-desired slope readings. The module should not be in motion and should not be vibrating.

Home Screen Selection

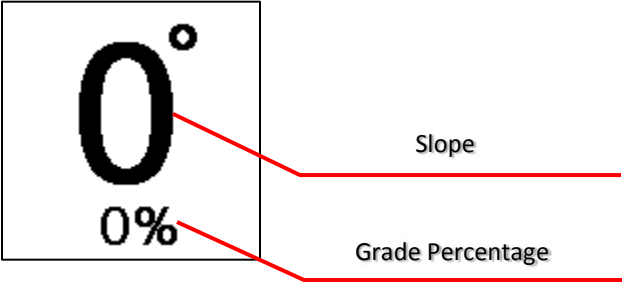


The home screen setting is located on the 5th page of the settings menu. The MPIC-Slope can only display one home screen at a time, so it gives you the option of choosing the home screen that will be the most helpful for the application you need it for. There is a total of 5 home screens to select from.

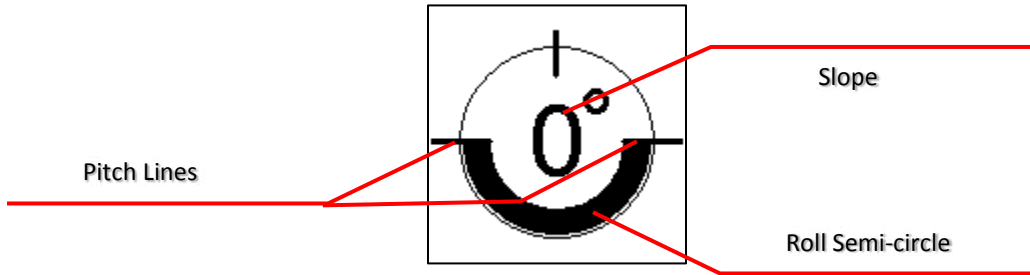
The first screen display slope in large font.



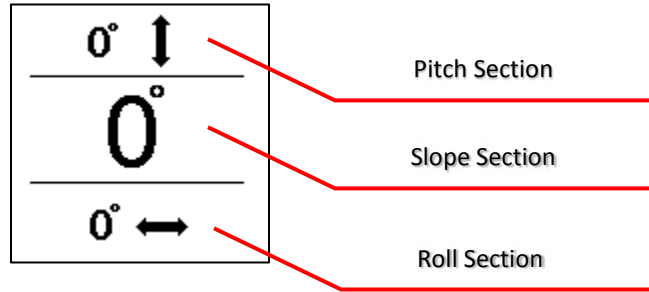
The second screen displays the slope and the grade percentage.



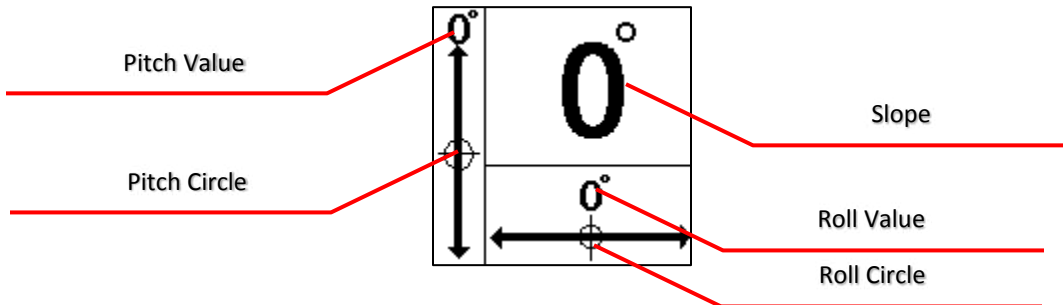
The third screen is inspired from attitude indicators on airplanes. When the pitch changes the two lines on the outside of the circle will go up and down following the pitch value. The black semi-circle will rotate left and right following the roll value. The number in the middle is the slope value.



The fourth screen displays the pitch, roll, and slope.

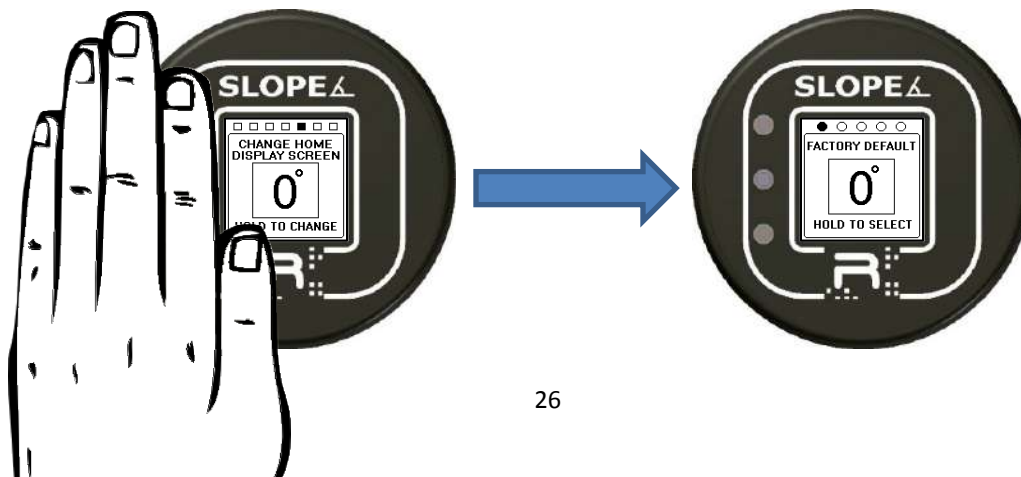


The fifth screen shows three different values: the pitch, the roll, and the slope. The roll and pitch both have bars with circles on them, which will move along the bar depending on the value of the pitch and roll.

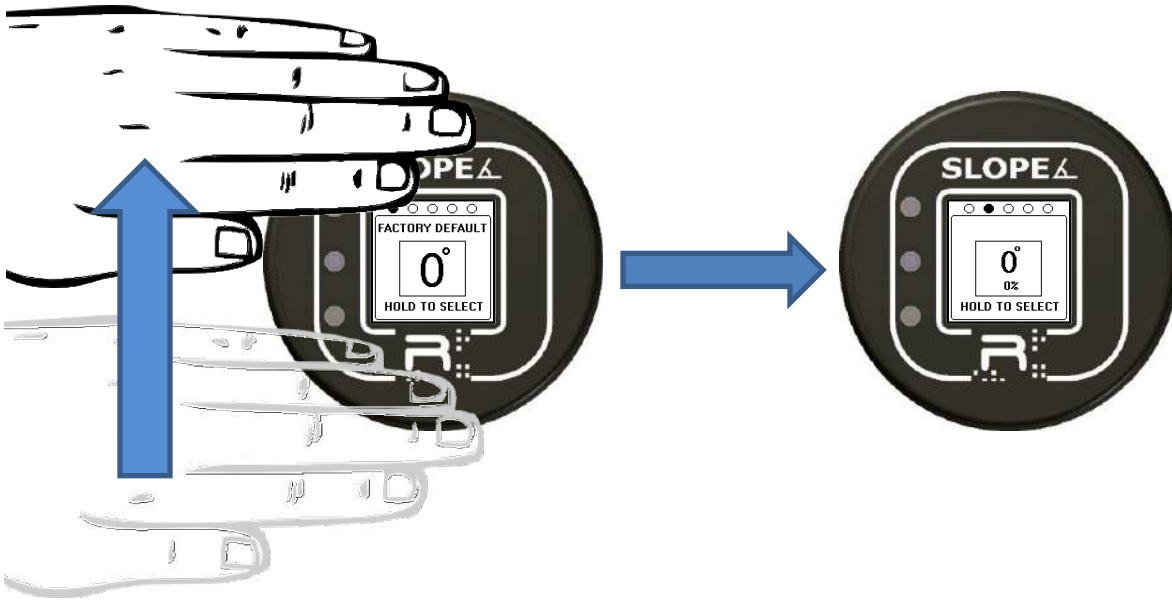


To change the home screen of the MPIC-Slope:

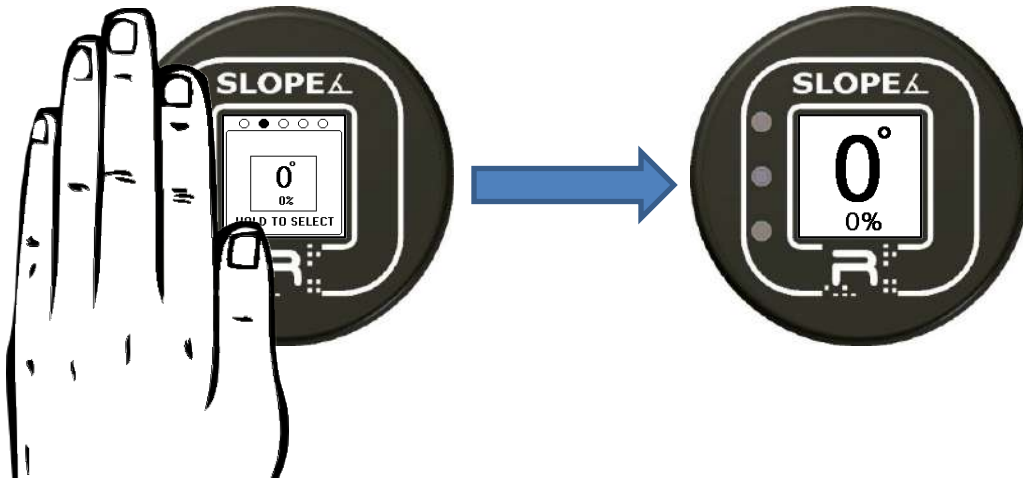
1. Perform a gesture recognition "Hold" for 3 seconds or until the screen changes.
 - a. If the user changes their mind, wait for the MPIC-Slope to time out in 30 seconds to go back in the settings menu.



2. The user will have to do a gesture recognition "Swipe" until the wanted home screen is shown. There are 5 home screens to choose from and each are represented by a circle at the top of the screen. The circle that is filled in is the home screen that is currently being shown.



3. Perform a gesture recognition "Hold" for 3 seconds or until the MPIC-Slope exits the settings menu and goes to the new home screen.

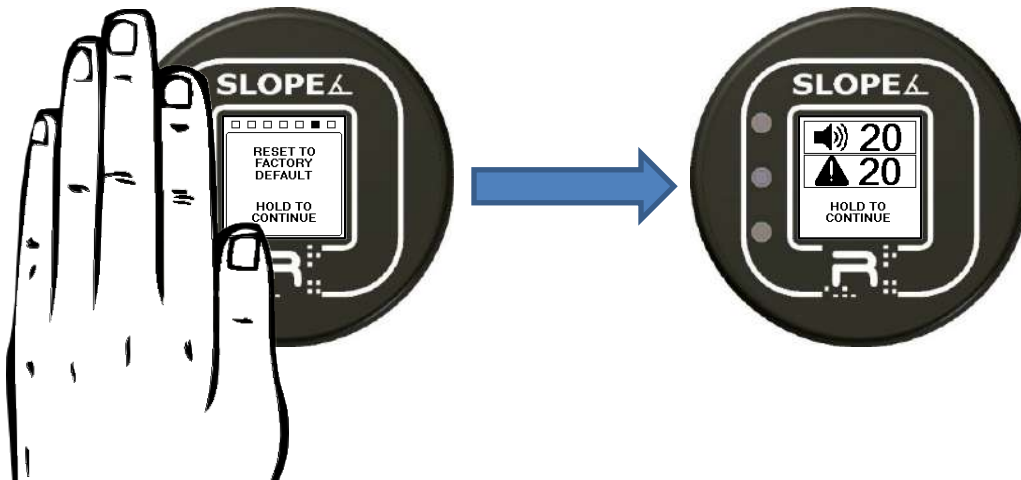


Reset to Factory Default

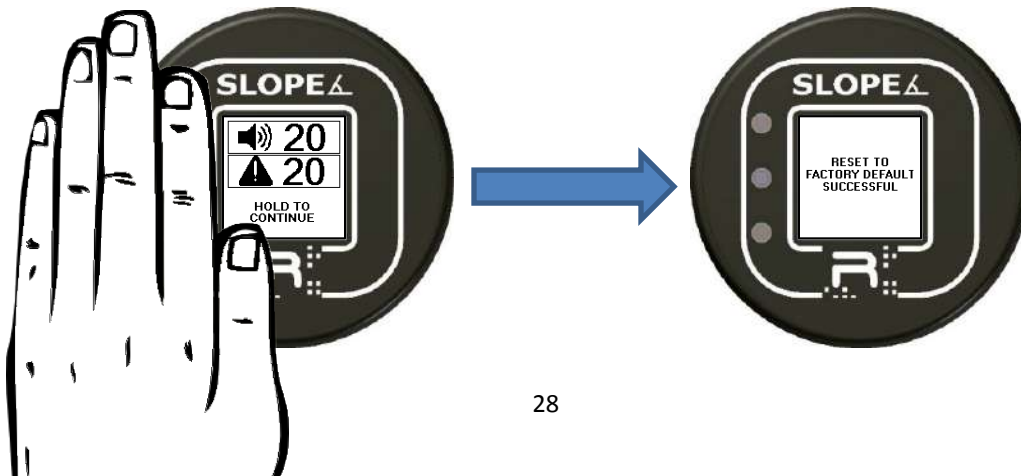


The factory reset setting is located on the 6th page of the settings menu. See Table 4.3 for the factory configurations. To reset the MPIC-Slope to the factory configurations:

1. Perform a gesture recognition "Hold" for 3 seconds or until the screen changes. The screen that it changes to shows what the set points will be changed to for the factory configuration.
 - a. If you perform a gesture recognition "Swipe", it will exit back to the settings menu.
 - b. The MPIC-Slope will time out in 30 seconds to go back in the settings menu.



2. Perform a gesture recognition "Hold" for 3 seconds or until the "factory default successful" screen.

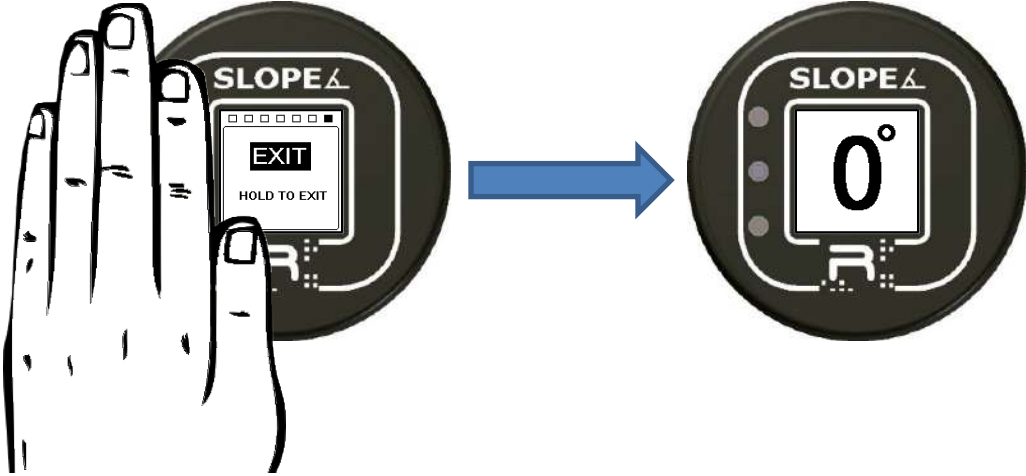


Exit Settings Menu



There are two ways to exit the settings menu:

- 1. If the MPIC-Slope is inactive for 30 seconds in the settings menu, it will exit the settings menu and go to the home screen.
- 2. On the 7th page of the settings menu, perform a gesture recognition "Hold" for 3 seconds or until the MPIC-Slope displays the home screen.



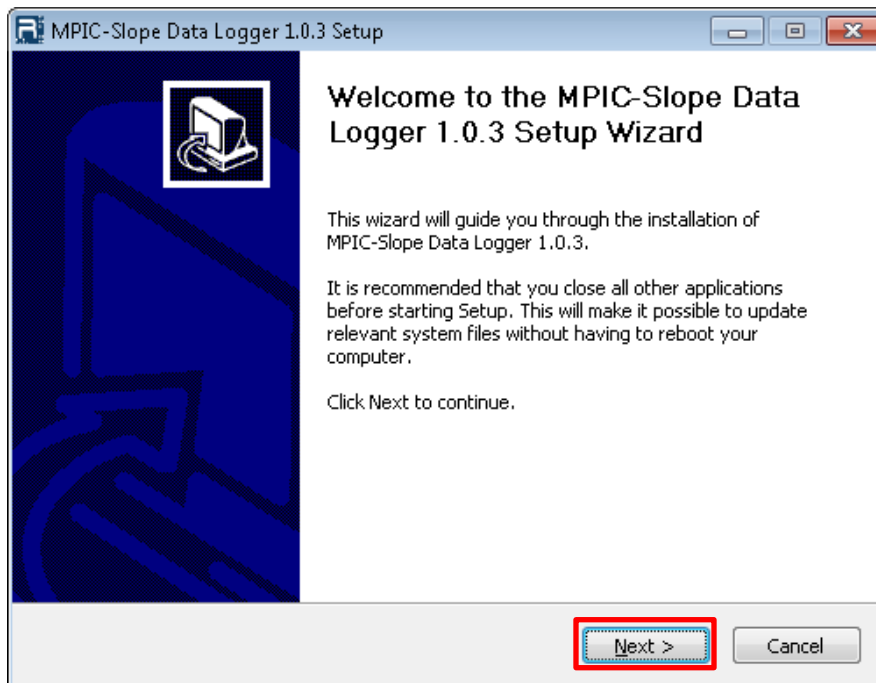
Chapter 5 – Data Logger

Data Logging

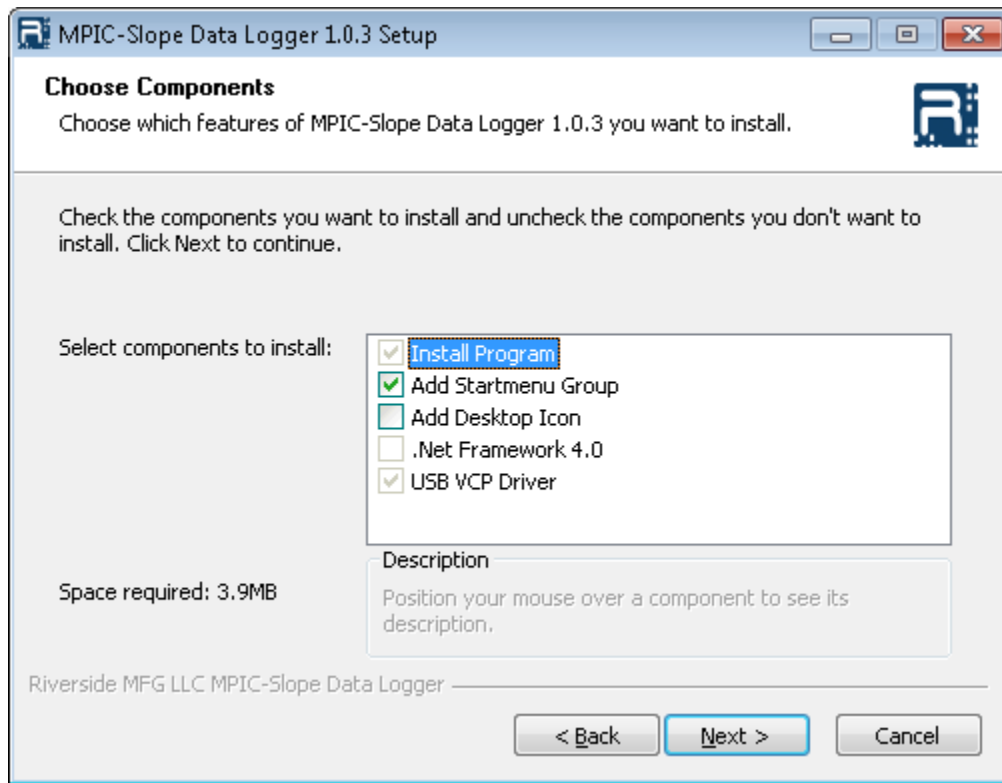
The MPIC-Slope has a software counterpart that can extract information from the module. The MPIC-Slope collects data when it is powered on like the settings configuration, when the settings configurations are changed, and the pitch and roll readings sampled every second. The memory has a potential of saving upwards of 72 hours' worth of pitch and roll data. The MPIC-Slope Data Logger Software requires Windows XP or greater.

Installation of MPIC-Slope Data Logger Software

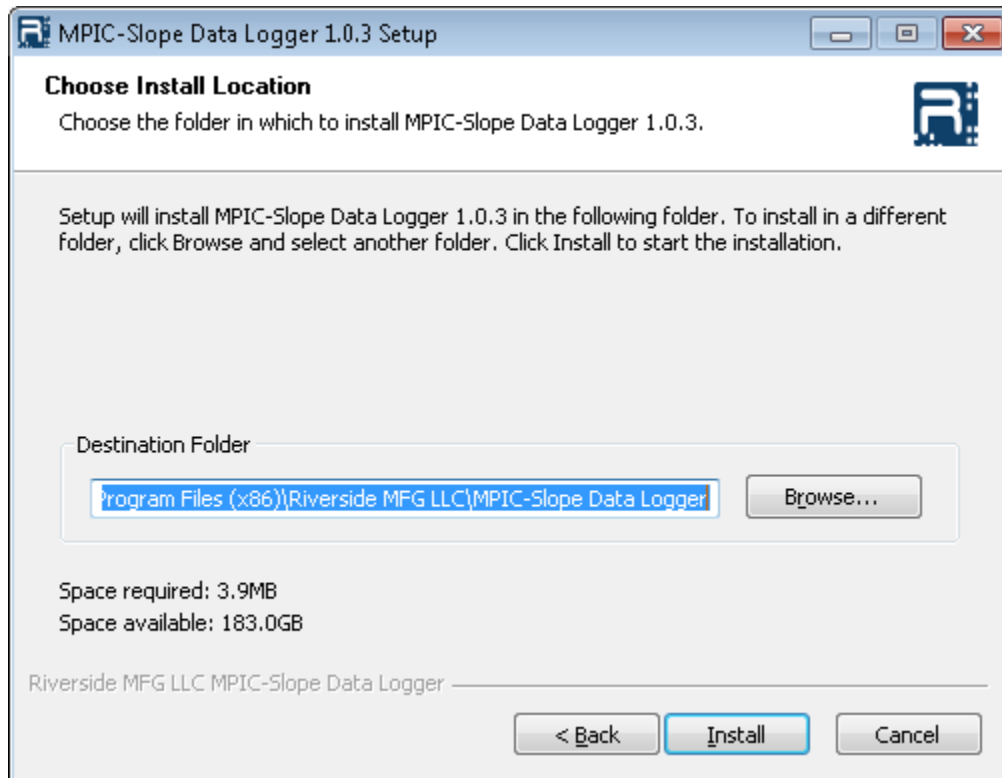
1. Download the MPIC-Slope Data Logger installer “MPIC-Slope-Datalogger-1.0.3-win32.exe” from <http://www.riversidemfg.com>
2. Double click the “MPIC-Slope-Datalogger-1.0.3-win32.exe” file.
3. Click the “Next” button.



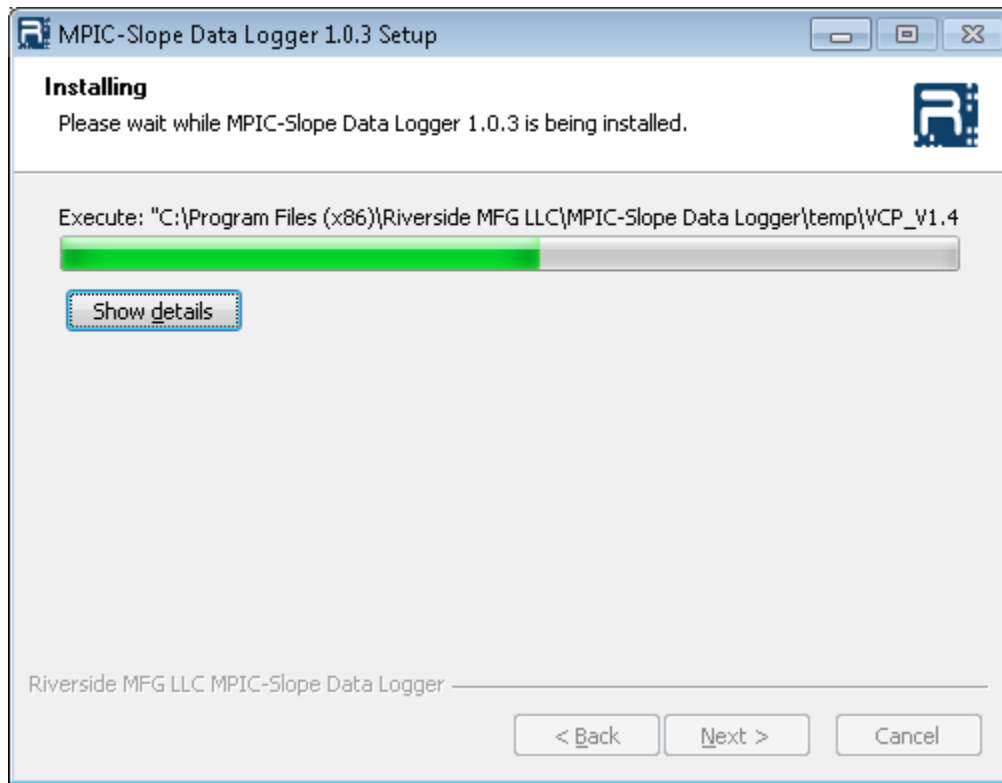
4. If you want to add a desktop icon be sure the check the “Add Desktop Icon” checkbox and click next.



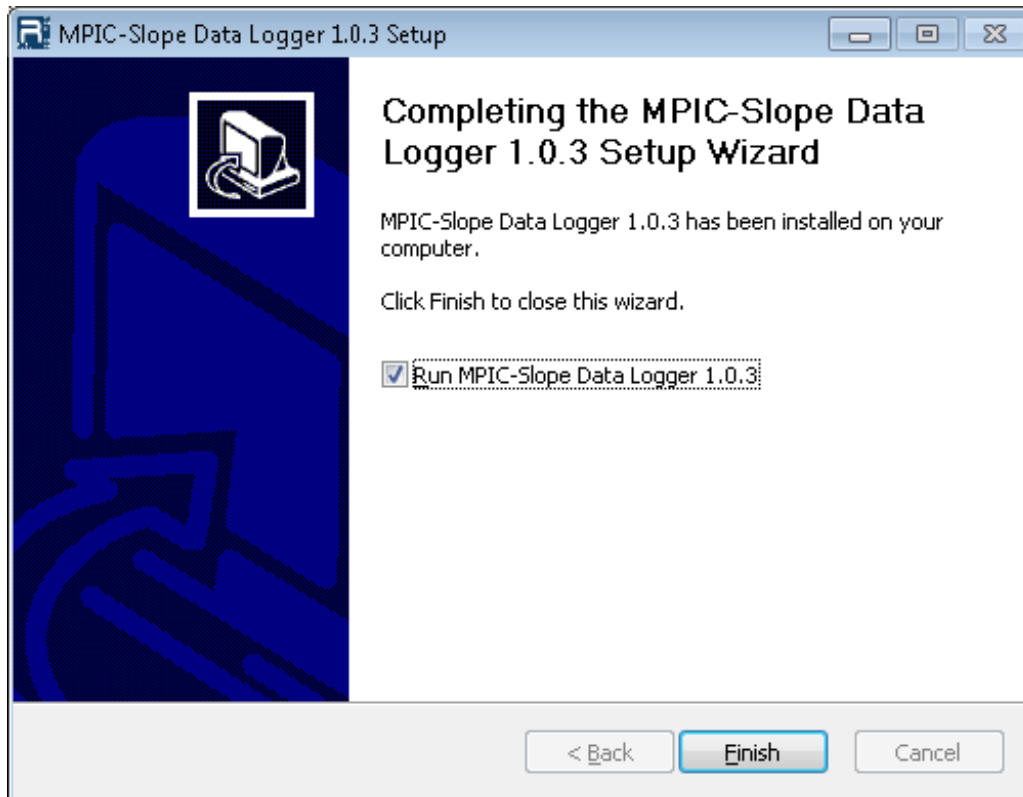
5. Choose the destination folder and press Install. The destination folder is where the software will be installed.



6. Wait for the software to finish installing.



7. If you want the software to open right away, check the "Run MPIC-Slope Data Logger 1.0.3" checkbox. Press Finish.



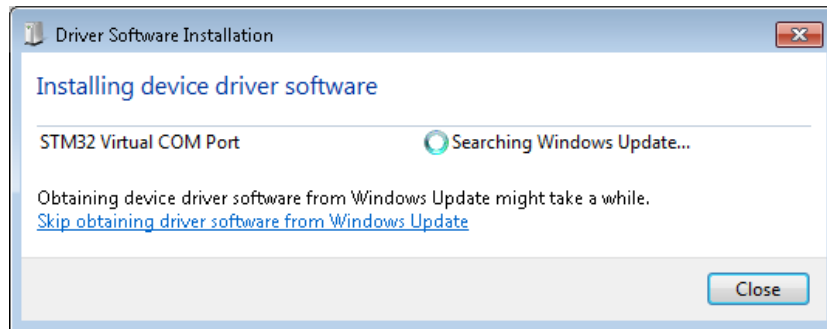
Connecting the MPIC-Slope to the MPIC-Slope Data Logger Software

1. Gather a Micro USB to USB cable shown in figure 5.1 and a PC with the MPIC-Slope Data Logger software installed on it.



FIGURE 5.1: MICRO USB TO USB CABLE.

2. Make sure no power is being applied to the MPIC-Slope module.
3. Remove the 4 screws on the back of the MPIC-Slope.
4. Plug in the Micro USB cable to the mating connector on the back of the board inside the MPIC-Slope and the USB into the PC.
5. Wait for the drivers to finish installing. It should only take a few minutes.



Note: If the driver has already been installed for that MPIC-Slope module, then skip this step.

6. Open the MPIC-Slop Data Logger software. Next to the "MPIC-Slope Connected" label should be a green bar that says "Connected" like in figure 5.2.



FIGURE 5.2: MAKE SURE THE LABEL INSIDE THE RED RECTANGLE IS GREEN AND SAYS "CONNECTED".

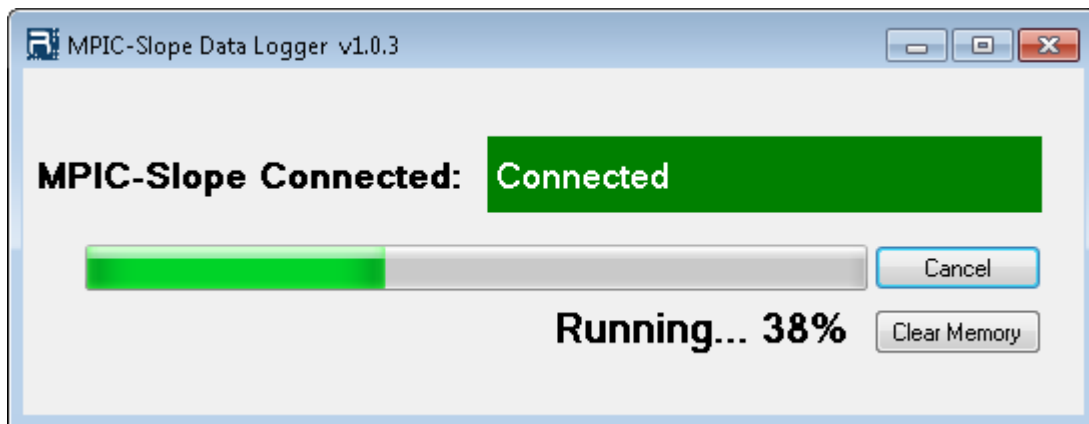
Download the MPIC-Slope Memory

1. Make sure the MPIC-Slope is connected by looking at the MPIC-Slope Data Logger software and making sure there is a green bar that says “Connected” next to the “MPIC-Slope Connected” label shown in figure 5.3.
2. Press the “Download” button shown in figure 5.3.

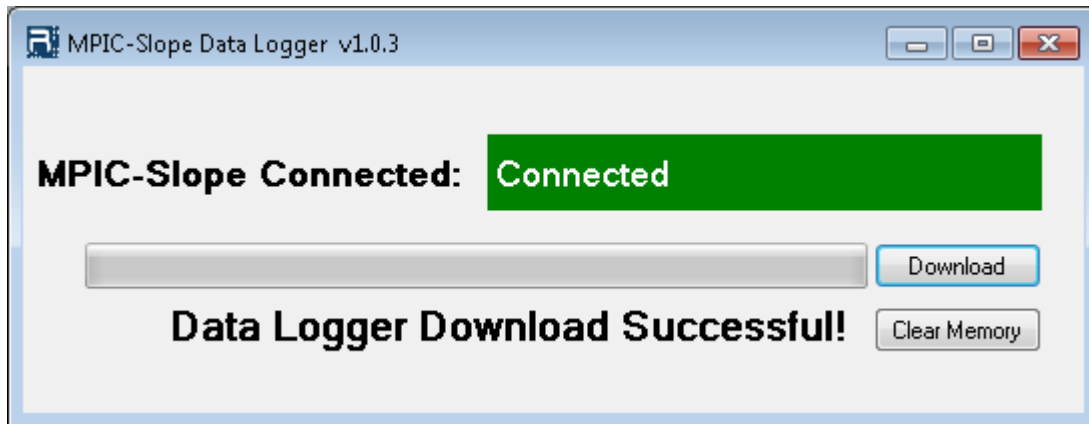


FIGURE 5.3: MAKE SURE THE LABEL INSIDE THE RED RECTANGLE IS GREEN AND DISPLAYS “CONNECTED” AND PRESS THE “DOWNLOAD” BUTTON INSIDE THE PURPLE RECTANGLE.

3. Choose where to download the data logger file and its name.
4. Downloading all of the MPIC-Slope data will take about 30 minutes.



5. MPIC-Slope Data Logger will display “Data Logger Download Successful!” when the download is complete.



Note: If cancel is pressed at any point during the download, any data that downloaded up to that point will be saved onto the computer in the location and file that was chosen at the start of the download.

Data Logger Download File

The first part of the Data logger download file contains all the current settings for the MPIC-Slope module. The trigger settings are the audible and visual set points. The “Audible Alarm Setting” is the audible alarm enable setting. The calibration values are both set behind the scenes when the MPIC-Slope module is calibrated. The startup count keeps track of how many times the module has been power on. Lastly, the home screen value is a numeric representation of what the current home screen is set to.

```
** Page: 0 **  
Audible Trigger Setting: 30  
Visual Trigger Setting: 25  
Audible Alarm Setting: off  
Calibration Pitch Value: -68.68198  
Calibration Roll Value: 33.41474  
Start-up Count: 158  
Home Screen: 1
```

The rest of the data is ordered from **OLDEST** to **NEWEST**. If the module has not recorded all ~72 hours’ worth of data, until the actual recorded data there will be a lot of text like this:

```
** Page: 432 **  
Page is empty
```

The actual data is formatted in a way that makes it easily ported to a spreadsheet. Each line of “Roll: x Pitch: x” can be seen as a second by second timeline of the MPIC-Slope being powered on. Here is what the actual data recorded can look like:

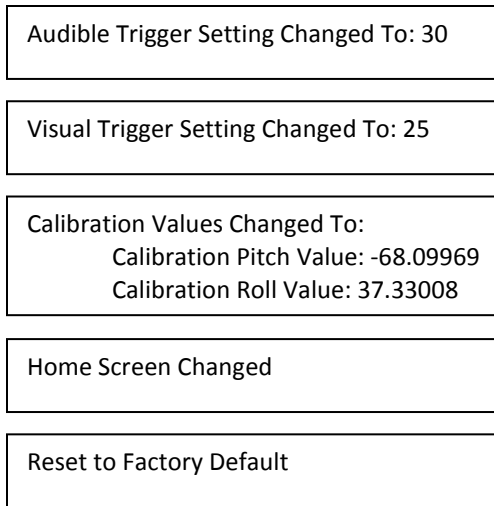
```
Digital Slope Gauge Powered On  
Roll: 1 Pitch: -95  
Roll: 1 Pitch: 106  
Roll: 1 Pitch: 87  
Roll: 1 Pitch: 80  
Roll: 1 Pitch: 78  
Digital Slope Gauge Powered On  
Roll: 0 Pitch: 93  
Roll: 0 Pitch: -109  
Roll: 0 Pitch: -90  
Roll: 0 Pitch: -83  
Digital Slope Gauge Powered On  
Roll: 0 Pitch: 93  
Roll: 0 Pitch: -109  
Roll: 0 Pitch: -89  
Roll: 0 Pitch: -83
```

In the middle of all the roll and pitch samples, there can be seen text of settings being changed. This kind of gives a timeline of when settings are changed relative to the roll and pitch samples and to what they are changed to.

```
Digital Slope Gauge Powered On
```

```
Audible Alarm Turned Off
```

```
Audible Alarm Turned On
```



Clear the MPIC-Slope Memory

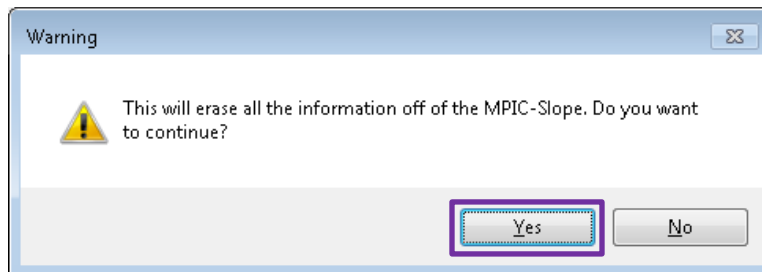
Clearing MPIC-Slope's memory will completely wipe it of anything that was data logged. Upon power up, the MPIC-Slope will start up with the factory settings configuration. This is different from factory reset in the settings menu because the clear memory will also erase all the pitch and roll data.

1. Make sure the MPIC-Slope is properly connected by looking at the MPIC-Slope Data Logger application and making sure there is a green bar that says "Connected" next to the "MPIC-Slope Connected" label shown in figure 5.4.
2. Press the "Clear Memory" button shown in figure 5.4.

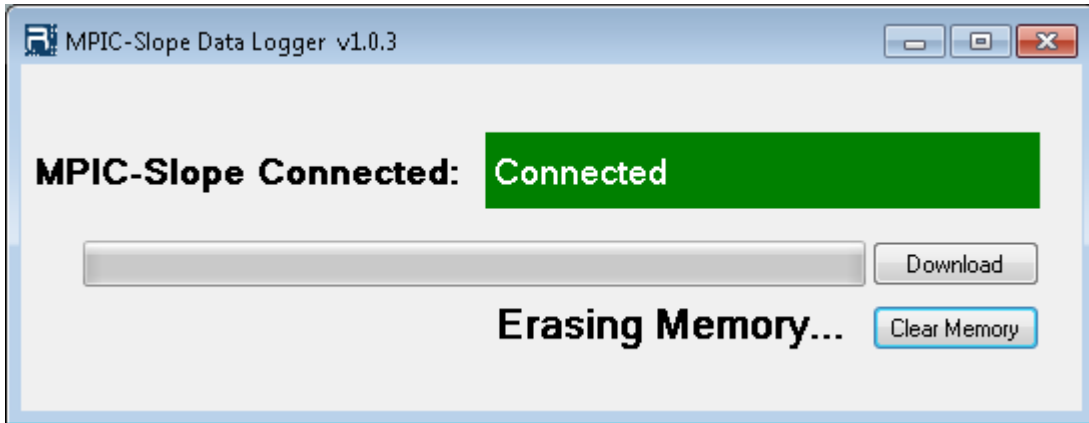


FIGURE 5.4: MAKE SURE THE LABEL INSIDE THE RED RECTANGLE IS GREEN AND SAYS "CONNECTED" AND PRESS THE "CLEAR MEMORY" BUTTON INSIDE THE PURPLE RECTANGLE.

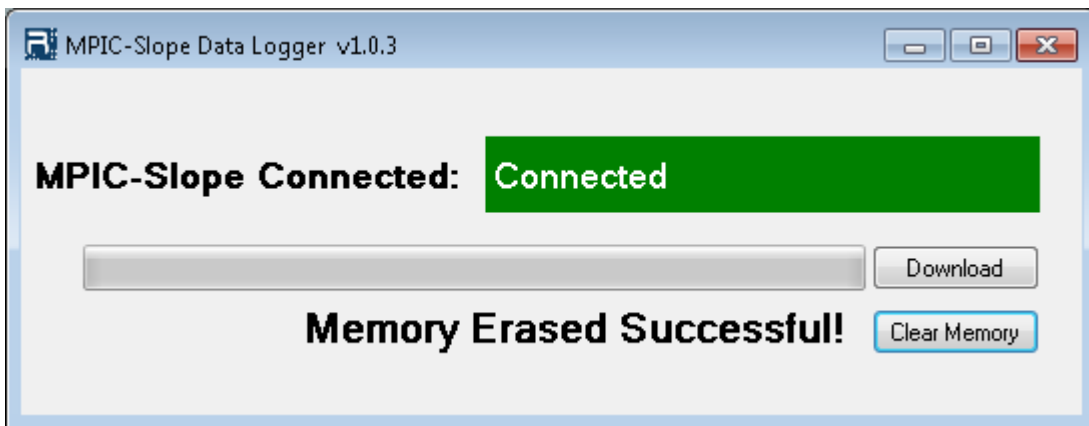
3. Press the "Yes" button.



- Erasing the memory will take about 1 minute.



- MPIC-Slope Data Logger will display "Memory Erased Successful!" when it is complete.



Chapter 6—Glossary

Glossary of Terms

Download - In computer networks, to download means to receive data to a local system from a remote system, or to initiate such a data transfer. Examples of a remote system from which a download might be performed include a webserver, FTP server, email server, or other similar systems. A download means the process of receiving such a file.

Firmware - In electronics and computing, firmware is a term used to denote the fixed, usually rather small, programs and/or data structures that internally control various electronic devices and microcontrollers.

Internet - The Internet is a global system of interconnected computer networks that use the standard Internet Protocol Suite (TCP/IP) to serve billions of users worldwide. It is a network of networks that consists of millions of private, public, academic, business, and government networks, of local to global scope, that are linked by a broad array of electronic and optical networking technologies..

PWM – Pulse Width Modulation. A method of varying the intensity of an output in multiple steps by varying the frequency of the output signal.

Protocol - A protocol is a set of guidelines or rules.

Software - Computer software, or just software, is the collection of computer programs and related data that provide the instructions telling a computer what to do. Software refers to one or more computer programs and data held in the storage of the computer for some purpose. Program software performs the function of the program it implements, either by directly providing instructions to the computer hardware or by serving as input to another piece of software.

Update – An update is designed to fix problems with, or update, a computer program or its supporting data. This improves the usability or performance of the system.

USB - Universal Serial Bus (USB) is a specification http://en.wikipedia.org/wiki/Usb - cite_note-0 to establish communication between devices and a host controller (usually personal computers). USB can connect computer peripherals such as mice, keyboards, digital cameras, printers, personal media players, flash drives, Network Adapters, and external hard drives.